

Specifications

Nominal Voltage		6 V
Capacity (25°C)	20HR(5.25V)	9Ah
	10HR(5.25V)	8.4Ah
	1HR(4.80V)	5.8Ah
Dimension	Length	151 ± 1.5mm (5.94inch)
	Width	34 ± 1mm (1.34inch)
	Height	94 ± 1mm (3.70inch)
	Total Height	100 ± 1mm (3.94inch)
Approx. Weight		1.35kg (2.98lbs) ± 5%
Terminal type		T1/T2
Internal resistance (Fully charged, 25°C)		Approx. 8m Ω
Capacity affected by temperature (20HR)	40°C	102%
	25°C	100%
	0°C	85%
	-15°C	65%
Self-discharge (25°C)	3 month	Remaining Capacity: 91%
	6 month	Remaining Capacity: 82%
	12 month	Remaining Capacity: 65%
Nominal operating temperature		25°C ± 3°C (77°F ± 5°F)
Operating temperature range	Discharge	-15°C ~ 50°C (5°F ~ 122°F)
	Charge	-10°C ~ 50°C (14°F ~ 122°F)
	Storage	-20°C ~ 50°C (-4°F ~ 122°F)
Float charging voltage(25°C)		6.80 to 6.90V Temperature compensation: -9mV/°C
Cyclic charging voltage(25°C)		7.25 to 7.45V Temperature compensation: -15mV/°C
Maximum charging current		2.7A
Terminal material		Copper
Maximum discharge current		135A(5 sec.)
Designed floating life(20°C)		3~5 years

- ◆ Absorbent glass mat technology;
- ◆ Recognized by UL & CE;
- ◆ ABS container.

Constant Current Discharge Characteristics (A, 25°C)

F.V/TIME	5min	10min	15min	30min	60min	2h	3h	4h	5h	10h	20h
4.80V	34.2	21.6	17.1	9.54	5.85	3.20	2.30	1.84	1.56	0.85	0.46
4.95V	33.2	21.0	16.7	9.35	5.76	3.18	2.28	1.83	1.55	0.85	0.45
5.10V	31.8	20.1	16.1	9.06	5.62	3.15	2.27	1.81	1.54	0.84	0.45
5.25V	30.4	19.2	15.5	8.84	5.50	3.10	2.25	1.80	1.53	0.84	0.45
5.40V	28.7	18.1	14.7	8.52	5.34	3.02	2.18	1.75	1.48	0.82	0.44

Constant Power Discharge Characteristics (Watt, 25°C)

F.V/TIME	5min	10min	15min	30min	60min	2h	3h	4h	5h	10h	20h
4.80V	191	122	97.5	54.7	33.9	18.7	13.6	10.9	9.32	5.10	2.74
4.95V	185	118	95.1	53.6	33.4	18.6	13.6	10.9	9.26	5.08	2.73
5.10V	177	113	91.6	51.9	32.5	18.4	13.5	10.8	9.20	5.05	2.72
5.25V	170	108	88.5	50.7	31.9	18.2	13.4	10.7	9.13	5.02	2.70
5.40V	160	102	83.8	48.8	30.9	17.7	13.0	10.4	8.86	4.92	2.65

Note: The above characteristics data can be obtained within three charge/discharge cycles.

Dimensions

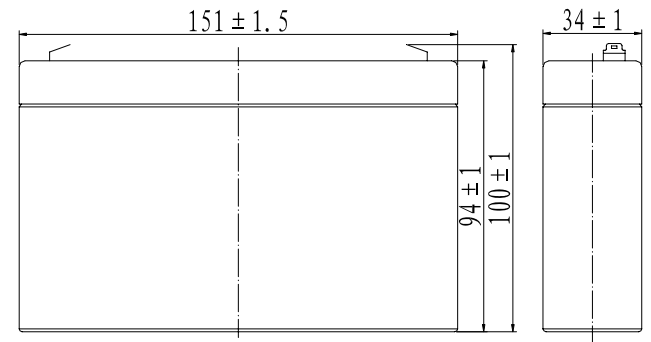

Terminal

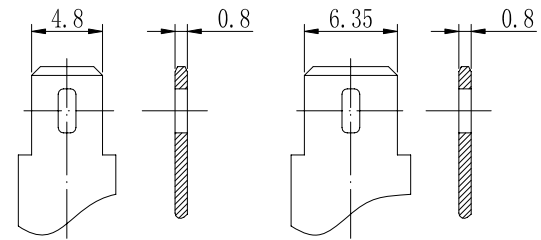

Terminal T1

Terminal T2

Discharge Characteristics(25°C)

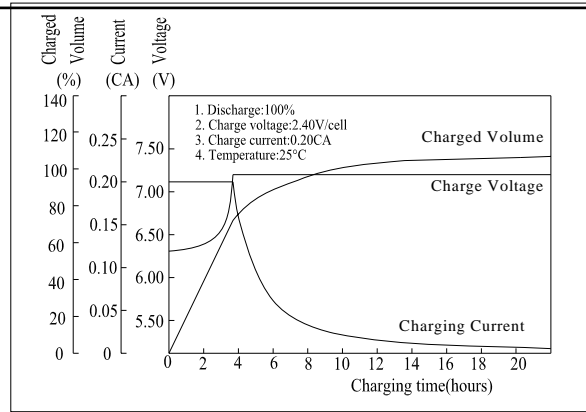
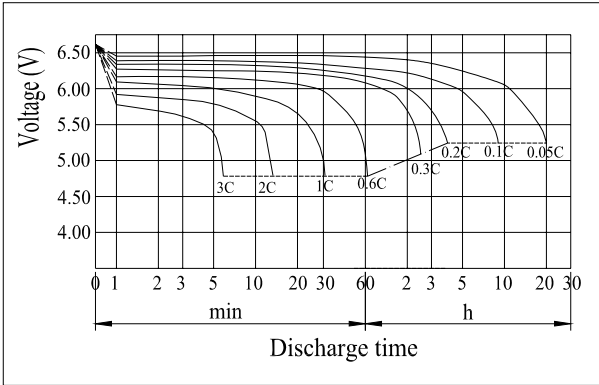

Effect of Temperature on Capacity

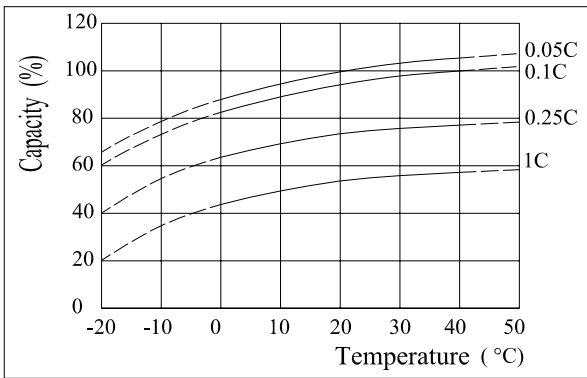

Self-discharge Characteristics

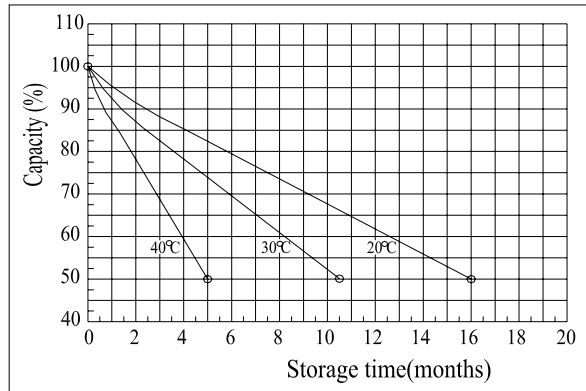

The Relationship for Open Circuit Voltage and Residual Capacity (25°C)

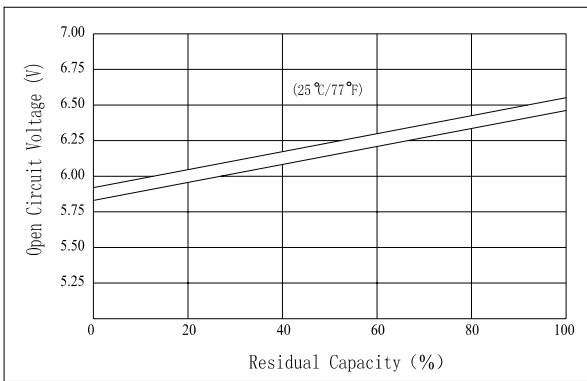

The Relationship for Charging Voltage and Temperature

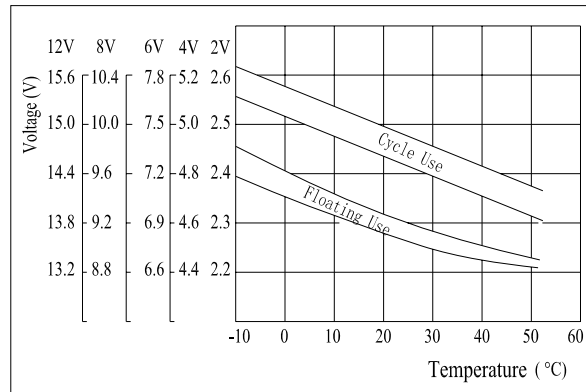

Floating Life on Temperature

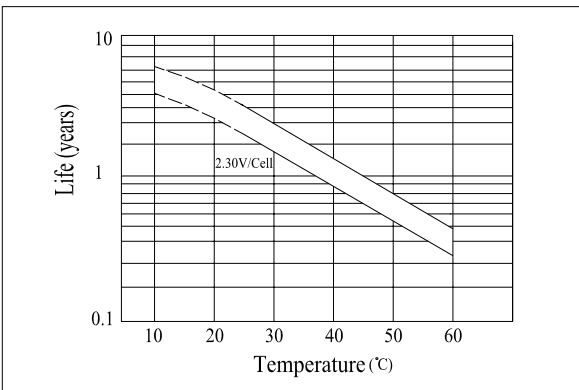

Cycle Life on D.O.D(25°C)

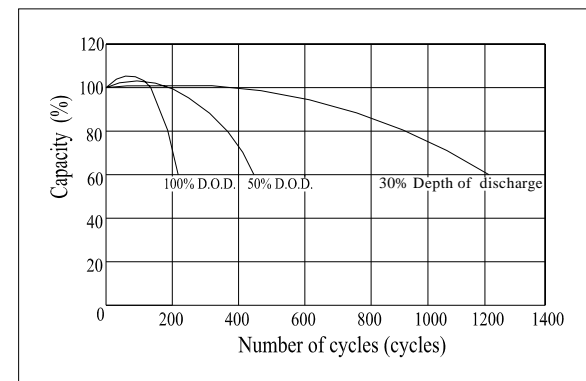

Charging Characteristics(25°C)