

**Specifications**

Nominal Voltage		6 V
Capacity (25°C)	20HR(5.25V)	3.2Ah
	10HR(5.25V)	3.0Ah
	1HR(4.80V)	2.08Ah
Dimension	Length	125 ± 1mm (4.92inch)
	Width	33 ± 1mm (1.30inch)
	Height	61 ± 1mm (2.40inch)
	Total Height	67 ± 1mm (2.64inch)
Approx. Weight		0.61kg (1.35lbs) ± 5%
Terminal type		T1
Internal resistance (Fully charged, 25°C)		Approx. 28mΩ
Capacity affected by temperature (20HR)	40°C	102%
	25°C	100%
	0°C	85%
	-15°C	65%
Self-discharge (25°C)	3 month	Remaining Capacity: 91%
	6 month	Remaining Capacity: 82%
	12 month	Remaining Capacity: 65%
Nominal operating temperature		25°C ± 3°C (77°F ± 5°F)
Operating temperature range	Discharge	-15°C ~ 50°C (5°F ~ 122°F)
	Charge	-10°C ~ 50°C (14°F ~ 122°F)
	Storage	-20°C ~ 50°C (-4°F ~ 122°F)
Float charging voltage(25°C)		6.80 to 6.90V Temperature compensation: -9mV/°C
Cyclic charging voltage(25°C)		7.25 to 7.45V Temperature compensation: -15mV/°C
Maximum charging current		0.96A
Terminal material		Copper
Maximum discharge current		48A(5 sec.)
Designed floating life(20°C)		3~5 years

**Dimensions**

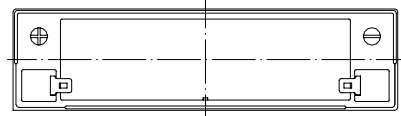
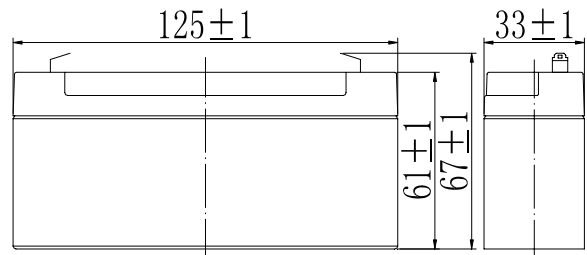

**Terminal**

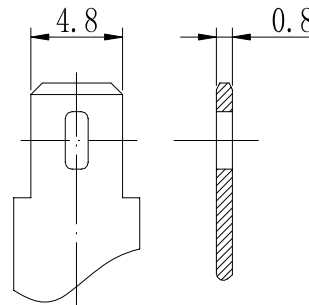

Terminal T1

- ◆ Absorbent glass mat technology;
- ◆ Recognized by UL & CE;
- ◆ ABS container.

**Constant Current Discharge Characteristics (A, 25°C)**

F.V/TIME	5min	10min	15min	30min	60min	2h	3h	4h	5h	10h	20h
4.80V	12.2	7.68	6.08	3.39	2.08	1.14	0.82	0.65	0.55	0.30	0.16
4.95V	11.8	7.45	5.93	3.32	2.05	1.13	0.81	0.65	0.55	0.30	0.16
5.10V	11.3	7.14	5.72	3.22	2.00	1.12	0.81	0.64	0.55	0.30	0.16
5.25V	10.8	6.84	5.52	3.14	1.96	1.10	0.80	0.64	0.54	0.30	0.16
5.40V	10.2	6.45	5.23	3.03	1.90	1.08	0.78	0.62	0.53	0.29	0.16

**Constant Power Discharge Characteristics (Watt, 25°C)**

F.V/TIME	5min	10min	15min	30min	60min	2h	3h	4h	5h	10h	20h
4.80V	67.9	43.3	34.7	19.4	12.0	6.65	4.85	3.89	3.31	1.81	0.97
4.95V	65.8	42.0	33.8	19.0	11.9	6.61	4.82	3.86	3.29	1.81	0.97
5.10V	63.1	40.3	32.6	18.5	11.6	6.55	4.79	3.84	3.27	1.80	0.97
5.25V	60.4	38.6	31.5	18.0	11.3	6.45	4.75	3.81	3.25	1.79	0.96
5.40V	57.0	36.4	29.8	17.4	11.0	6.29	4.61	3.70	3.15	1.75	0.94

Note: The above characteristics data can be obtained within three charge/discharge cycles.

**Discharge Characteristics(25°C)**

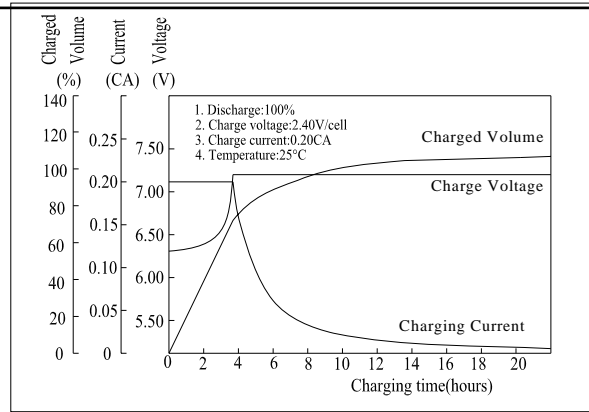
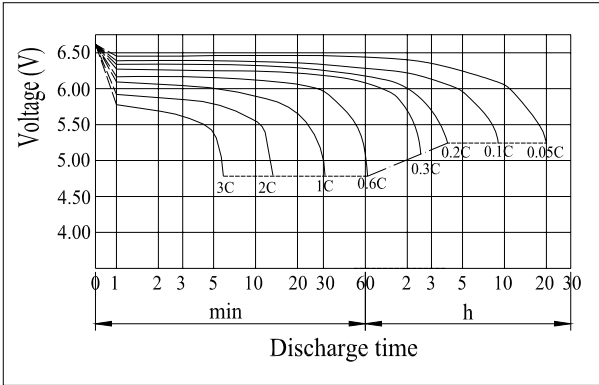

**Effect of Temperature on Capacity**

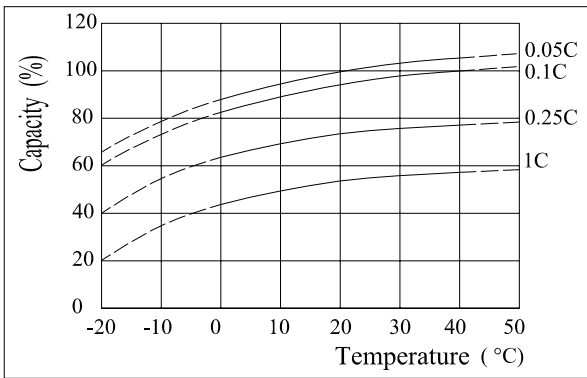

**Self-discharge Characteristics**

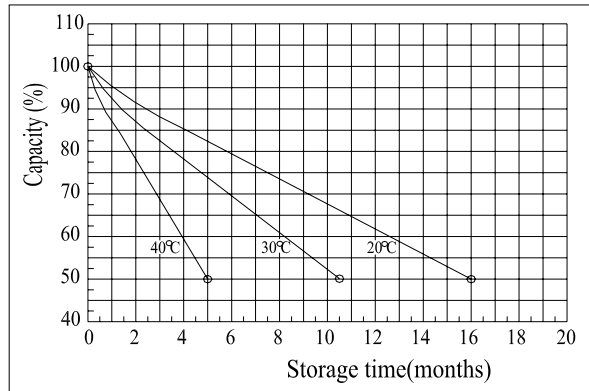

**The Relationship for Open Circuit Voltage and Residual Capacity (25°C)**

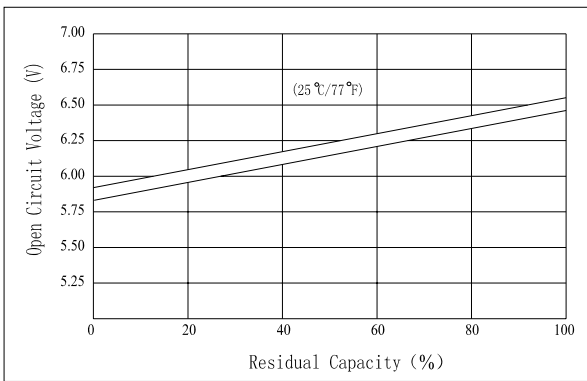

**The Relationship for Charging Voltage and Temperature**

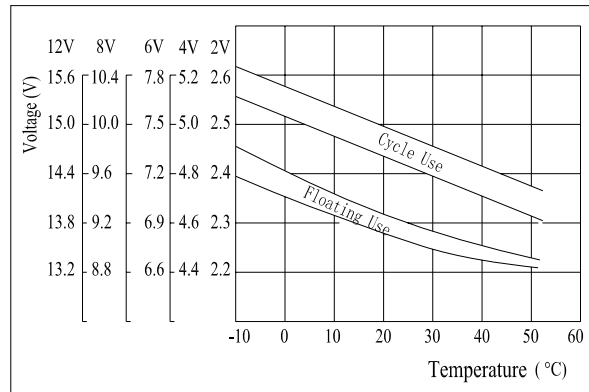

**Floating Life on Temperature**

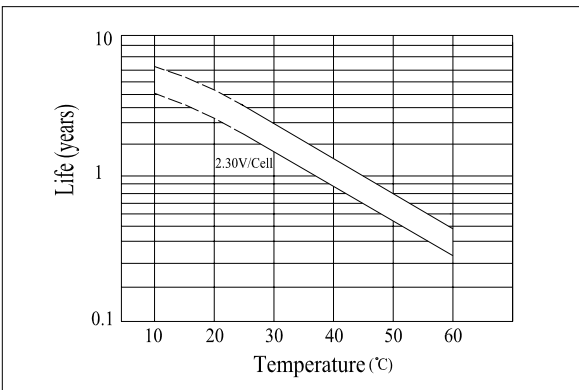

**Cycle Life on D.O.D(25°C)**

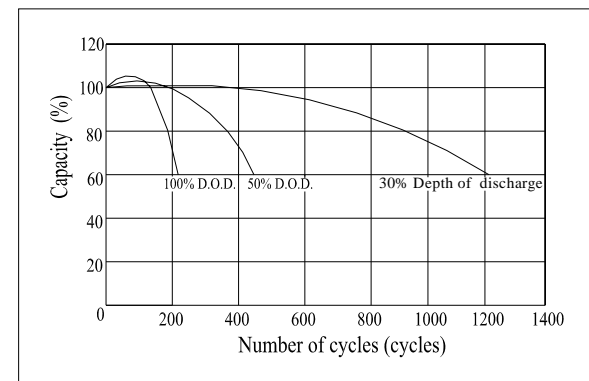

**Charging Characteristics(25°C)**