

Specifications

Nominal Voltage		6 V
Capacity (25°C)	20HR(5.25V)	1.3Ah
	10HR(5.25V)	1.12Ah
	1HR(4.80V)	0.78Ah
Dimension	Length	97 ± 1mm (3.82inch)
	Width	24 ± 0.5mm (0.94inch)
	Height	52 ± 1mm (2.05inch)
	Total Height	58 ± 1mm (2.28inch)
Approx. Weight		0.28kg (0.62lbs) ± 5%
Terminal type		T1
Internal resistance (Fully charged, 25°C)		Approx. 52mΩ
Capacity affected by temperature (20HR)	40°C	102%
	25°C	100%
	0°C	85%
	-15°C	65%
Self-discharge (25°C)	3 month	Remaining Capacity: 91%
	6 month	Remaining Capacity: 82%
	12 month	Remaining Capacity: 65%
Nominal operating temperature		25°C ± 3°C (77°F ± 5°F)
Operating temperature range	Discharge	-15°C ~ 50°C (5°F ~ 122°F)
	Charge	-10°C ~ 50°C (14°F ~ 122°F)
	Storage	-20°C ~ 50°C (-4°F ~ 122°F)
Float charging voltage(25°C)		6.80 to 6.90V Temperature compensation: -9mV/°C
Cyclic charging voltage(25°C)		7.25 to 7.45V Temperature compensation: -15mV/°C
Maximum charging current		0.36A
Terminal material		Copper
Maximum discharge current		18A(5 sec.)
Designed floating life(20°C)		3~5 years

Dimensions

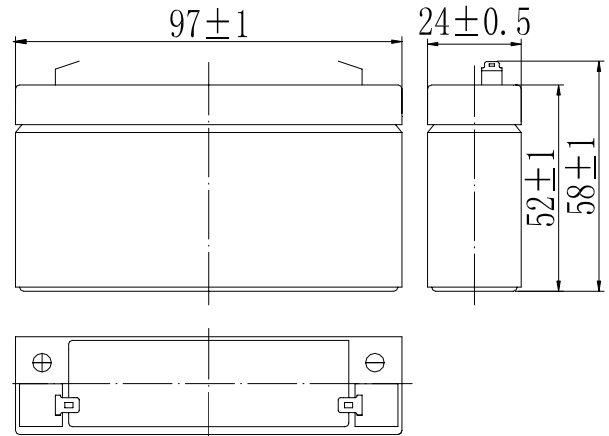

Terminal

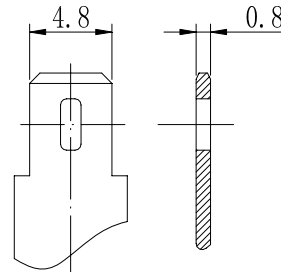

Terminal T1

- ◆ Absorbent glass mat technology;
- ◆ Recognized by UL & CE;
- ◆ ABS container.

Constant Current Discharge Characteristics (A, 25°C)

F.V/TIME	5min	10min	15min	30min	60min	2h	3h	4h	5h	10h	20h
4.80V	4.56	2.88	2.28	1.27	0.78	0.43	0.306	0.245	0.208	0.113	0.061
4.95V	4.42	2.79	2.23	1.25	0.77	0.42	0.304	0.243	0.207	0.113	0.061
5.10V	4.24	2.68	2.14	1.21	0.75	0.42	0.302	0.242	0.205	0.112	0.060
5.25V	4.06	2.56	2.07	1.18	0.73	0.41	0.300	0.240	0.204	0.112	0.060
5.40V	3.83	2.42	1.96	1.14	0.71	0.40	0.291	0.233	0.198	0.109	0.059

Constant Power Discharge Characteristics (Watt, 25°C)

F.V/TIME	5min	10min	15min	30min	60min	2h	3h	4h	5h	10h	20h
4.80V	25.4	16.2	13.0	7.29	4.52	2.49	1.82	1.46	1.24	0.68	0.37
4.95V	24.7	15.8	12.7	7.14	4.45	2.48	1.81	1.45	1.23	0.68	0.36
5.10V	23.7	15.1	12.2	6.92	4.34	2.46	1.79	1.44	1.23	0.67	0.36
5.25V	22.6	14.5	11.8	6.76	4.25	2.42	1.78	1.43	1.22	0.67	0.36
5.40V	21.4	13.6	11.2	6.51	4.12	2.36	1.73	1.39	1.18	0.66	0.35

Note: The above characteristics data can be obtained within three charge/discharge cycles.

Discharge Characteristics(25°C)

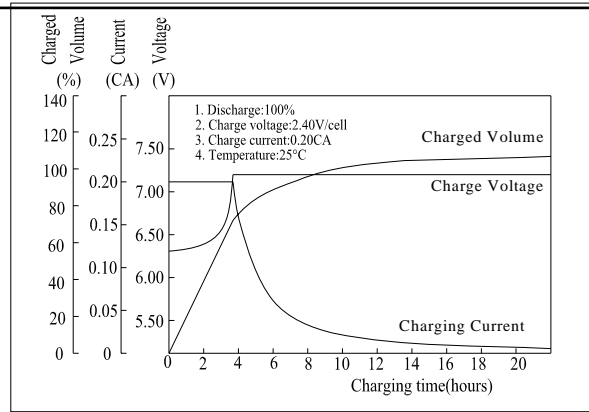
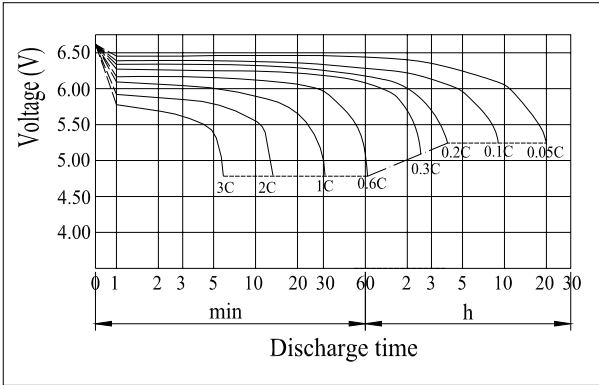

Effect of Temperature on Capacity

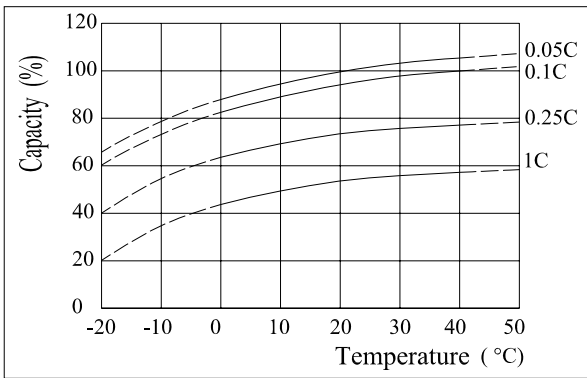

Self-discharge Characteristics



The Relationship for Open Circuit Voltage and Residual Capacity (25°C)

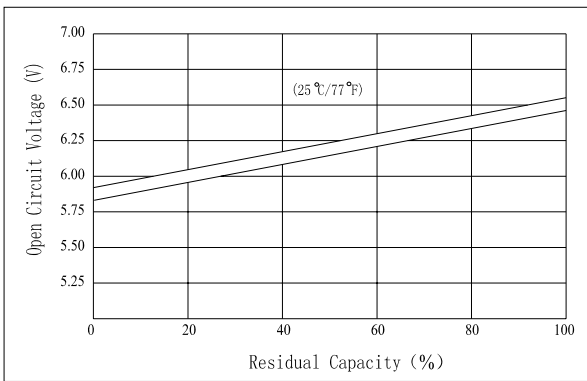

The Relationship for Charging Voltage and Temperature



Floating Life on Temperature

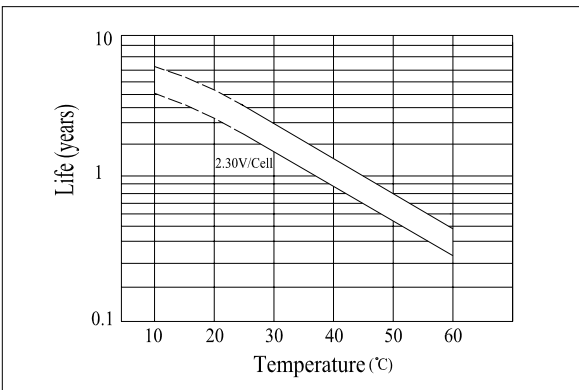

Cycle Life on D.O.D(25°C)

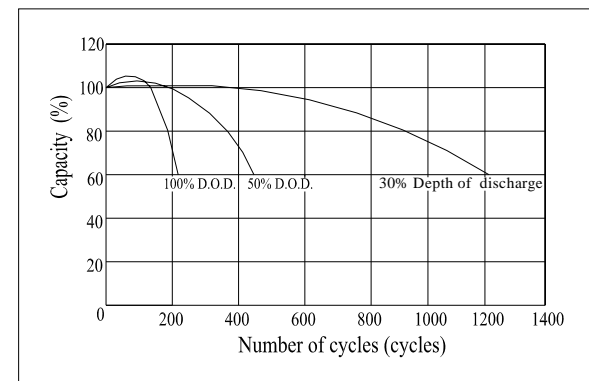

Charging Characteristics(25°C)